

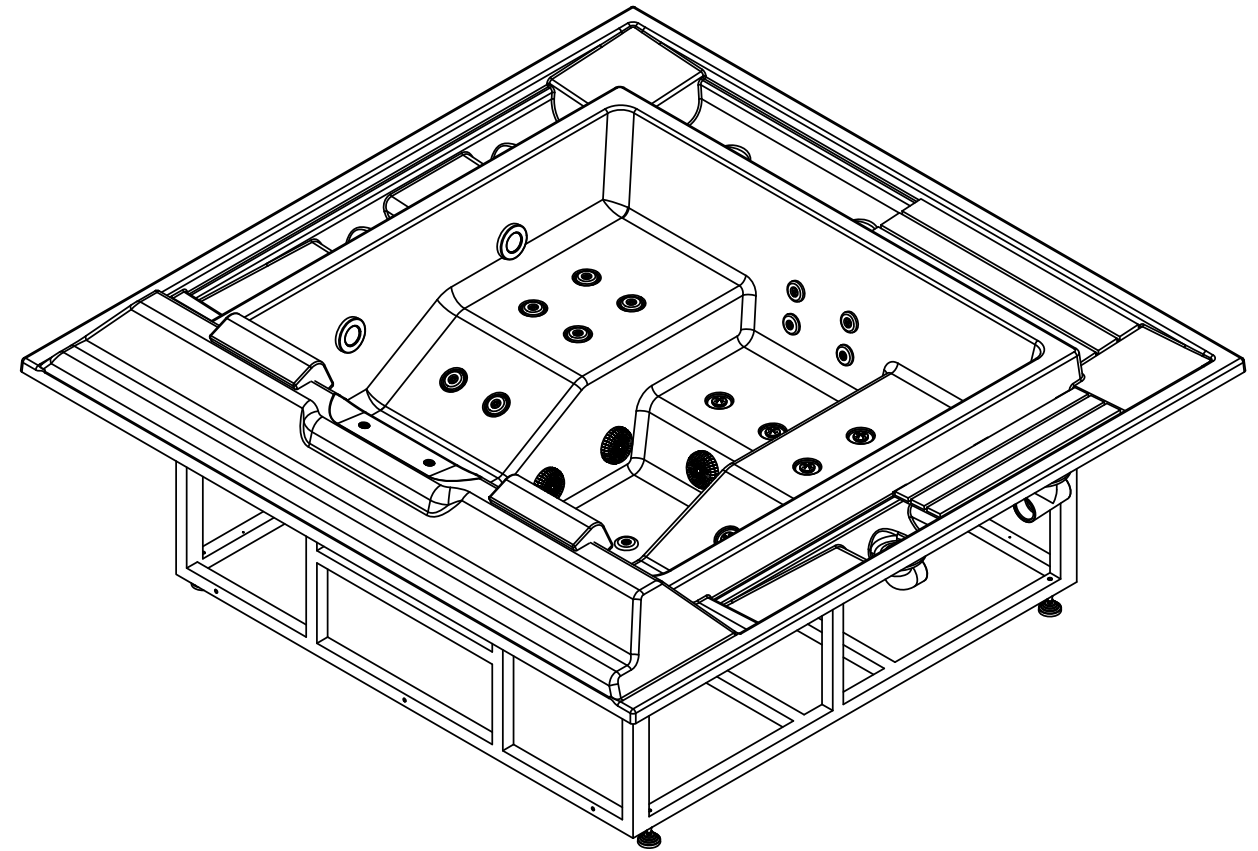

↑ ↑
HYDRAULIC CONNECTIONS ACCESS



According to our policy of continuous improvement, dimensions, features or components of this product can be partially or completely changed without prior notice. It's Customer responsibility to verify that this is the last version of the drawing

01	31/03/2014	I.Pozo	New templates				
00	14/09/2010	J.Jorba	Drawing creation				
Change No.	Date	Name	Modification				
Remarks				COMMERCIAL			
Dimensions in mm. General Tolerances +/- 10mm							
Drawn	14/09/2010	J.Jorba			Part Number	Rev.	First Angle Projection
Checked	-	I.Nicolas					
Scale 1:20	General Tolerance				53680	01	
Sheet 1/3	DIN 7168 ISO 2768g						
Property of IBERSPA S.L. Avda. Pla d'Urgell 2-8 25200 Cervera, Spain. Don't use without permission. Keep this information confidential and use it solely for the permitted purpose.							

A	Suction-Water Massage Pump 1	Ø 63 BSP FEMALE THREAD
B	Return-Water Massage Pump 1	Ø 63 BSP FEMALE THREAD
C	Return-Air Massage	Ø 63 BSP FEMALE THREAD
D	Suction/Return-Filtration Pump Bottom Spa	Ø 63 BSP FEMALE THREAD
E	Return-Filtration Pump Inlets	Ø 63 BSP FEMALE THREAD
F	Overflow Drains (7x)	Ø 63 BSP FEMALE THREAD

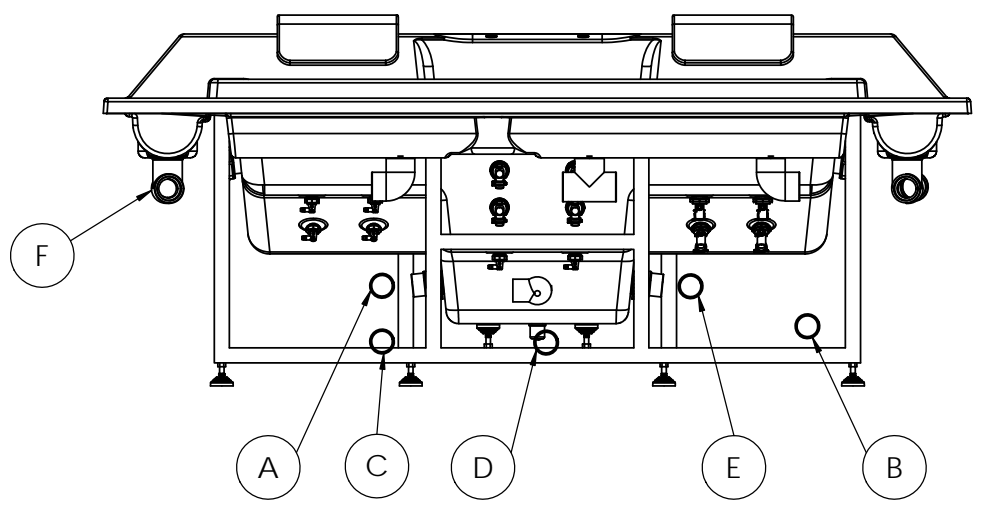
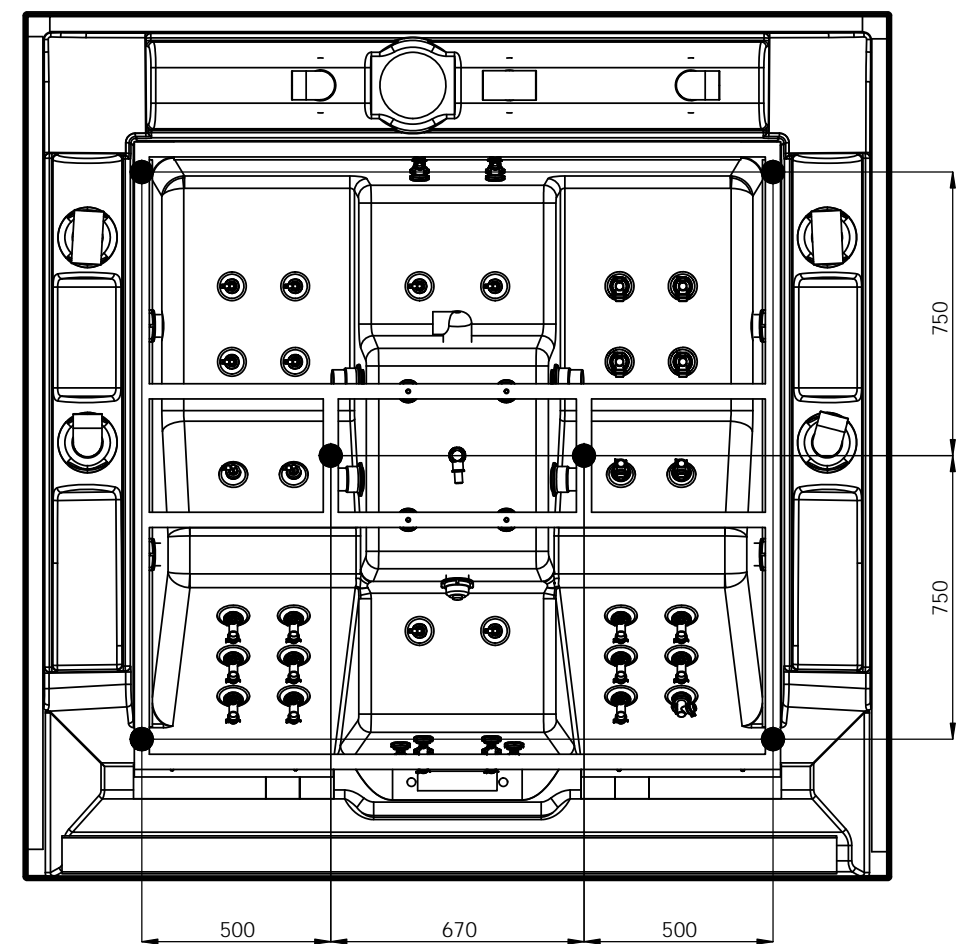

WARNING:
It's essential to keep a minimum clearance access of **700mm** all around.

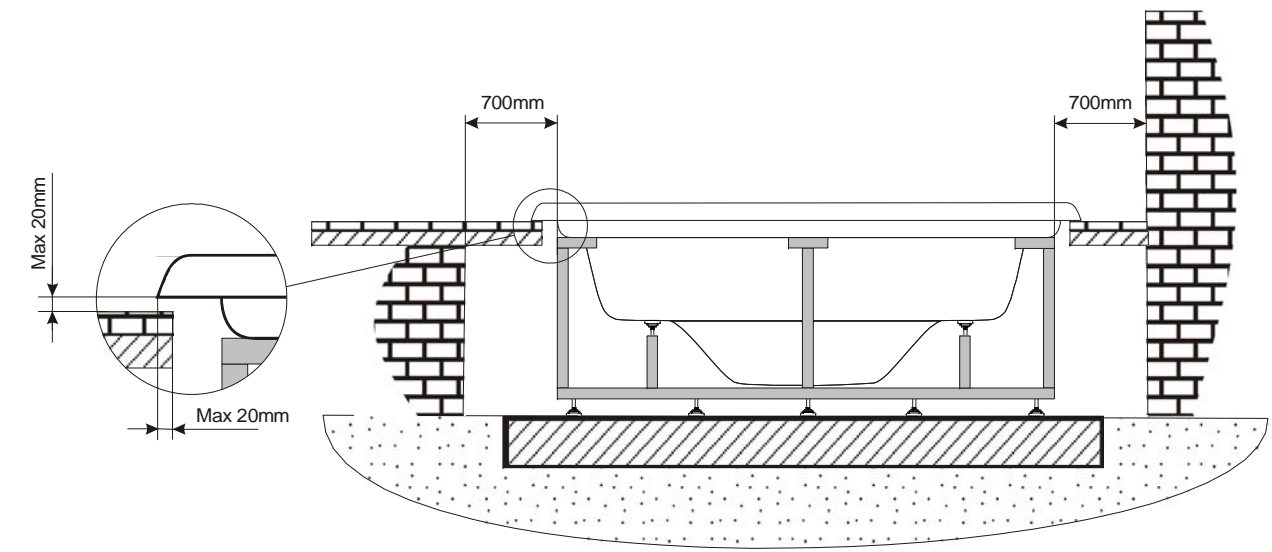

According to our policy of continuous improvement, dimensions, features or components of this product can be partially or completely changed without prior notice.
It's Customer responsibility to verify that this is the last version of the drawing

Change No.				Date				Name				Modification					
Remarks								COMMERCIAL									
Dimensions in mm. General Tolerances +/- 10mm																	
Drawn	14/09/2010	J.Jorba															
Checked	--	I.Nicolas															
Scale 1:20	General Tolerance																
Sheet 2/3	DIN 7168 ISO 2768g																
Property of IBERSPA S.L. Avda. Pla d'Urgell 2-8 25200 Cervera, Spain. Don't use without permission. Keep this information confidential and use it solely for the permitted purpose.												Part Number		Rev.		First Angle Projection	
								53680				01					

STAINLESS STEEL JETS + COLOUR LIGHT

Position Num.	Part Nº SPARE	Description SPARE	Quant.
1	303325R	SPA SUPPORT	6
2	RPOR0223	WHITE SPA DRAIN 2" ADAPTOR SOCKET D.50	4
3	RPOR0224	WHITE SPA DRAIN 2" ADAPTOR ELBOW 90 D.50	1
4	REMP0046	WHITE-STAINLESS STEEL AIR NOZZLE	10
5	REMP0055	PRESSURE NOZZLE 63 (GASKET 2 UNITS)	7
6	REMP0034	DIGITAL BUTTON IP68 ALUM. AIR	1
7	REMP0033	DIGITAL BUTTON IP68 ALUM. WATER	1
8	RPOR0001	WHITE DRAIN SET 1/2"	1
10	RCOM0063	HIGH INTENSITY COLOURS LED SPOTLIGHTS + STEEL ESCUTCHEON SPOTLIGHT	5
15	RPOR0235	JET BODY SET RD 2"	28
16	RPOR0230	FRONTAL JET 2" STAINLESS STEEL DIRECTIONAL	12
17	RPOR0260	JET TWIN ROTO 2" INOX	16
32	RPOR0215	BLACK HEADREST BARCELONA SPA	2
40	RPOR0271	FRONT GRATING BCN SPA	2
41	RPOR0272	SIDE GRATING BCN SPA	4

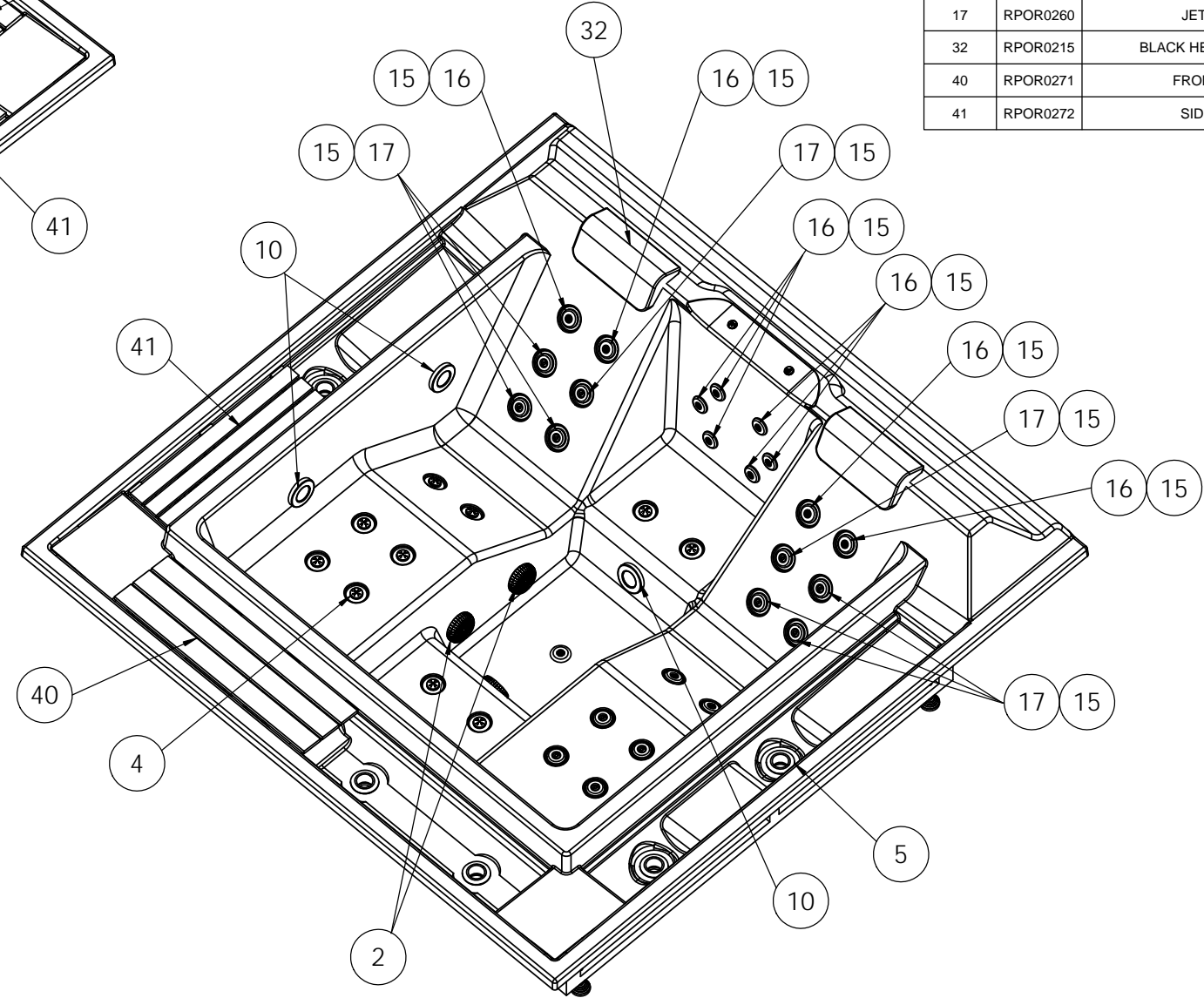
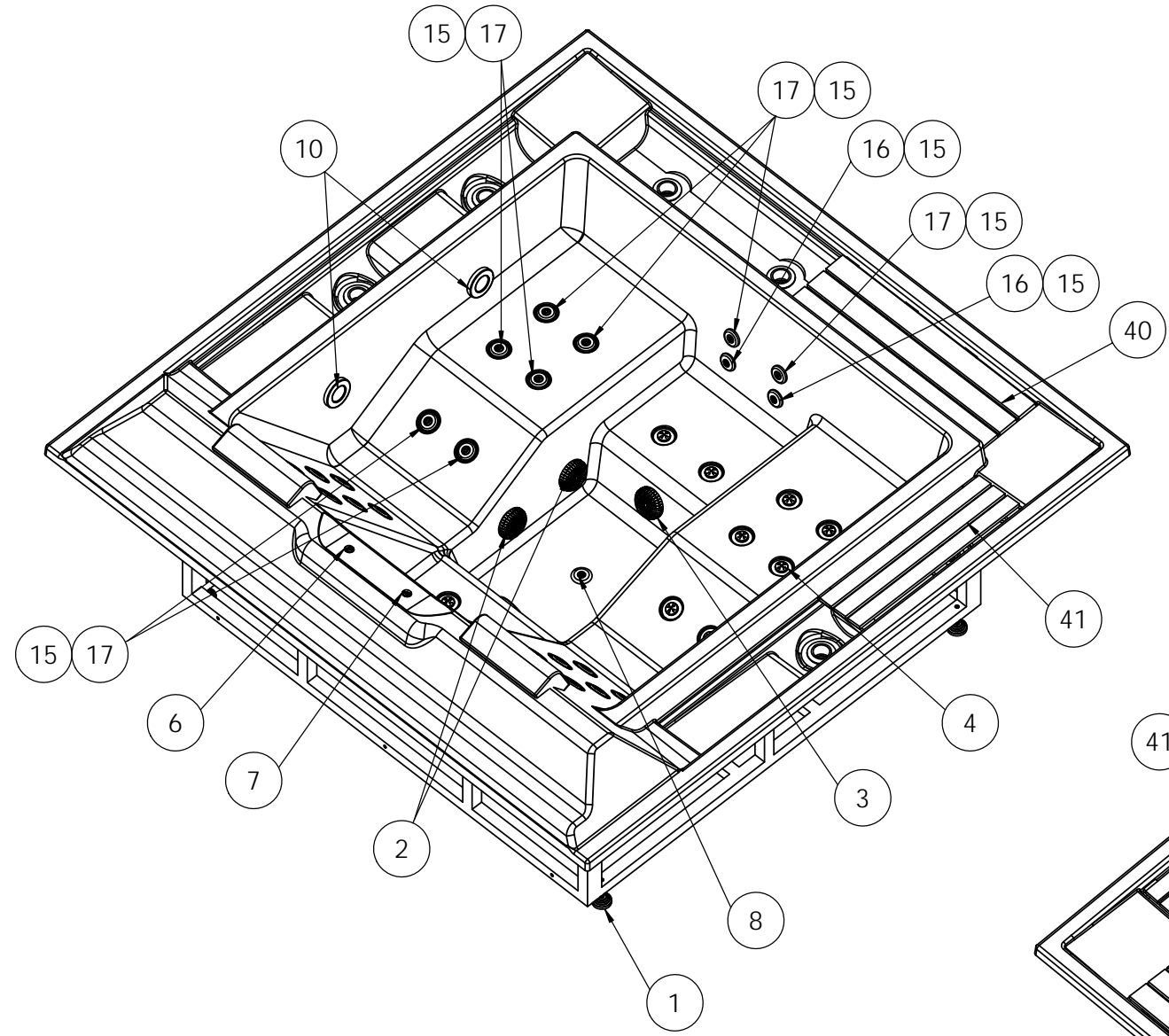

According to our policy of continuous improvement, dimensions, features or components of this product can be partially or completely changed without prior notice. It's Customer responsibility to verify that this is the last version of the drawing

Change No.	Date	Name	Modification
01	31/03/2014	I.Pozo	New templates
00	14/09/2010	J.Jorba	Drawing creation

Remarks Dimensions in mm. General Tolerances +/- 10mm			SPARE DRAWING			
Drawn	14/09/2010	J.Jorba		Part Number 53680	Rev. 01	First Angle Projection
Checked	-	I.Nicolas				
Scale	1:20		General Tolerance DIN 7168 ISO 2768g			
Sheet	3/3					